

# Table of Contents

1	Introduction .....	3
1.1	What is the Vivo 40? .....	4
1.2	Intended Use .....	4
1.3	Contraindications .....	5
1.4	About this Manual .....	6
2	Safety Information .....	8
2.1	General User Precautions .....	8
2.2	Electrical Safety .....	10
2.3	Environmental Conditions .....	11
2.4	Usage of Patient Circuit .....	12
2.5	Invasive Use .....	14
2.6	Usage of Filters .....	15
2.7	Humidification .....	15
2.8	Cleaning and Maintenance .....	16
2.9	Adverse Patient Symptoms .....	17
2.10	Usage of Oxygen .....	18
3	Product Description .....	20
3.1	Main Components .....	20
3.2	Accessories .....	22
3.3	The Vivo 40's Front Panel .....	23
3.4	The Vivo 40's Back and Side Panels .....	24
3.5	Equipment Designation and Safety Label .....	25
4	Functions and Parameters of the Vivo 40 .....	26
4.1	Ventilation Mode .....	26
4.2	Settings .....	26
4.3	Standby and Operating Mode .....	26
4.4	Low Leakage Detection .....	27
4.5	Humidifier (optional) .....	27
5	Using the Vivo 40 .....	28
5.1	Set up the Vivo 40 Before Use .....	28
5.2	Switching the Vivo 40 On and Off .....	29
5.3	Using the Menu .....	30
5.4	Monitoring Section .....	34
5.5	Using the HA 01 Humidifier .....	35
5.6	Using Batteries .....	36
5.7	Vivo 40 Operating Time .....	39
6	Preparing the Vivo 40 for Use .....	40
6.1	Installing the Vivo 40 .....	40
6.2	Placing the Vivo 40 .....	41
6.3	Connecting the Vivo 40 to the AC Power Source .....	41
6.4	Connecting the Patient Circuit .....	43
7	Alarms .....	45
7.1	Alarm Function .....	45
7.2	Physiological Alarm .....	47

7.3	Technical Alarm.....	54
8	Cleaning the Vivo 40 and Replacement of Accessories .....	57
8.1	Cleaning the Vivo 40 .....	57
8.2	Cleaning and Replacing the Patient Air Filters.....	59
9	Maintenance .....	61
9.1	Regular Maintenance Control .....	61
9.2	Service and Repair.....	62
9.3	Storage.....	62
9.4	Disposal .....	62
10	Technical Specifications .....	63
10.1	Data .....	63
11	Accessories.....	68
11.1	Breas Accessories List.....	68
12	Patient Settings.....	69

# 1 Introduction



## **WARNING!**

Vivo 40 must only be used:

- For the intended treatment in accordance with this operating manual and with the instructions given by the responsible clinical personnel.
- In accordance with the operating conditions specified in this operating manual.
- In original and unmodified shape and only with accessories specified or approved by Breas Medical AB.

Every other use may lead to risk of personal injury!



## **CAUTION!**

Read this operating manual thoroughly so that you completely understand how the Vivo 40 is operated and maintained before taking it into use, to ensure correct usage, maximum performance and serviceability.



## **WARNING!**

Do not use the Vivo 40 for any kind of total ventilatory requirement.



Breas Medical AB reserves the right to make changes to this product without any prior notification.

## 1.1 What is the Vivo 40?

The Vivo 40 is a pressure-supported and pressure-controlled ventilator.

It has three modes of operation: PCV (Pressure Control Ventilation), PSV (Pressure Support Ventilation) and CPAP (Continuous Positive Airway Pressure). The PCV and PSV modes have an adjustable inspiratory trigger sensitivity setting which allows the patient to initiate ventilator-assisted breaths.

- In the PCV mode (Pressure Control Ventilation), the ventilator provides assisted or controlled pressure-regulated breathing. In PCV mode, the clinician sets an inspiration time. The inspiratory pressure is set by the IPAP (Inspiratory Positive Airway Pressure) setting. The end-expiratory pressure is set by the EPAP (Expiratory Positive Airway Pressure) setting.
- In the PSV mode (Pressure Support Ventilation), the ventilator's expiratory trigger can also be adjusted allowing the ventilator to more easily match each patient's needs. The inspiratory pressure is set by the IPAP setting. The end-expiratory pressure is set by the EPAP setting.
- In the CPAP mode (Continuous Positive Airway Pressure), the ventilator provides a continuous positive airway pressure.

The Vivo 40 has a pressure sensor that continuously monitors output pressure to the patient and reference ambient pressure, so that the device automatically will compensate for altitude changes.

## 1.2 Intended Use

The Vivo 40 is an assist ventilator intended to augment the breathing of spontaneously adult patients >66 lbs (>30 kg) suffering from respiratory failure, respiratory insufficiency, or obstructive sleep apnea.

The Vivo 40 is not intended to provide the total ventilatory requirements of the patient.

The Vivo 40 is intended to be used for both invasive and non-invasive applications.

The Vivo 40 is intended to be operated by qualified and trained personnel.

The Vivo 40 is intended for use in clinical settings (e.g., hospitals, sleep laboratories, sub-acute care institutions) and home environments. The Vivo 40 must always be prescribed by a licensed physician.

The CPAP function is intended to deliver continuous positive airway pressure therapy for the treatment of obstructive sleep apnea, via non-invasive nasal or full-face masks.

### 1.3 Contraindications

The use of the Vivo 40 is contraindicated on patients with severe respiratory failure without a spontaneous respiratory drive.

The use of the Vivo 40 for positive pressure therapy may be contraindicated on patients:

- Incapable of maintaining life- sustaining ventilation in the event of a brief circuit disconnection or loss of therapy.
- Unable to maintain a patent airway or adequately clear secretions.
- At risk for aspiration of gastric contents.
- With a history of allergy or hypersensitivity to the mask materials where the risk from allergic reaction outweighs the benefit of ventilatory assistance.

Therapy with the Vivo 40 should **not** be prescribed when the following specific diseases or conditions are present:

- Bullous lung disease
- Pathologically low blood pressure
- Severe cardiac arrhythmias
- Coronary artery disease
- Unstable angina pectoris
- Decompensated cardiac failure or hypotension, particularly if associated with intravascular volume depletion
- Recent thoracic surgery
- Pneumothorax
- Pneumomediastinum
- Massive epistaxis or previous history of massive epistaxis (risk of recurrence)
- Pneumoencephalus, recent trauma or surgery that may have produced cranio-nasopharyngeal fistula

- Cerebral spinal fluid (CSF) leaks
- Acute or unstable respiratory failure or insufficiency
- Conditions predisposing to a risk of aspiration of gastric contents
- Impaired ability to clear secretions

Caution should be used when prescribing positive airway pressure therapy for susceptible patients, such as patients with abnormalities of the cribriform plate, or prior history of head trauma.

The use of CPAP therapy may be temporarily contraindicated if the patient exhibits signs of a sinus or middle ear infection.

## 1.4 About this Manual



**Always read this manual before setting up and using the Vivo 40 or performing maintenance on the machine, to ensure correct usage, maximum performance and serviceability.**



**Breas Medical AB reserves the right to make changes to the contents of this manual without any prior notification.**

### Audience





This manual is intended for patients and other lay users operating the Vivo 40.



*Care providers, clinical personnel, physicians and others who require a working knowledge of the Vivo 40 will find additional information on settings and functions in the Clinician's Manual.*

## Icons

In this manual, icons are used to highlight specific information. The meaning of each icon is explained in the table below.

ICON	EXPLANATION
	<b>Warning!</b> Risk of death and serious personal injury.
	<b>Caution!</b> Risk of minor or moderate injury. Risk of equipment damage, loss of data, extra work, or unexpected results.
	<b>Note</b> Information that may be valuable but is not of critical importance, tips.
	<b>Reference</b> Reference to other manuals with additional information on a specific topic.

## 2 Safety Information

### 2.1 General User Precautions



- The Vivo 40 must be switched off and on at least once a day. This is necessary in order for the Vivo 40 to perform a self test.
- U.S. Federal law restricts this device for sale by or on order of a physician.
- The Vivo 40 should not be used for any kind of total ventilatory requirement.
- The Vivo 40 shall only be used by patients with spontaneous breathing.
- Advice contained in this manual should not supersede instructions given by the prescribing physician.
- If you are admitted to a hospital or are prescribed any other form of medical treatment, always inform the medical staff that you are on mechanical ventilation treatment.
- Vivo 40 must only be used:
  - for the intended treatment in accordance with this operating manual and with the instructions given by the responsible clinical personnel;
  - in accordance with the operating conditions specified in this operating manual;
  - in original and unmodified shape and only with accessories specified or approved by Breas Medical AB.
- Do not use the Vivo 40 in the event of suspected damage to the device, unexplainable or sudden pressure, performance or sound changes during operation, or if the delivered air from the Vivo 40 is abnormally hot or emits an odor. Contact your responsible care provider for an inspection.
- Inadequate use of device or accessories may cause loss of treatment or decreased performance.
- The Vivo 40 therapy settings must always be based on medical supervision and must be changed by authorized clinical personnel only. Blood gas measurement should be performed when changing settings or changing to another device.



- Always perform the procedure “Set up the Vivo 40 Before Use” on page 28 before using the Vivo 40.
- Only use accessories recommended by Breas Medical AB.



- Clinical personnel must read the Clinician’s manual thoroughly and understand the Vivo 40 operation before setting up and using the machine.
- The user must read the user manual thoroughly and understand the Vivo 40 operation before using the machine.
- All the physiological alarms of the Vivo 40 must be set at safe levels that will effectively warn the user of any risk. The alarm levels should be assessed considering the patient settings. Any change of settings or components may require the readjustment of the alarm levels.
- Handle the Vivo 40 with care.
- Make sure to place and pack the device in a way that prevents unintentional start of the machine. Due to the internal battery, the Vivo 40 may start if the Start/Stop button is pressed even without the AC power being connected.
- Do not use the Vivo 40 while in a carry bag. Attach the rear lid and place the swivel in a down position when placing the Vivo 40 in the bag.
- If using the Vivo 40 for a short intra hospital or vehicle transportation, the following cautions need to be observed:
  - Do not mount the Vivo 40 on a wheelchair or in a vehicle.
  - Make sure that the Vivo 40 stands securely in a upright position and cannot tilt or fall.
  - Do not use the Vivo 40 outdoors during rain or snowfall.
  - If the HA 01 humidifier is attached, make sure that it is not in use and that it is empty.

## 2.2 Electrical Safety



- Do not operate the Vivo 40 if it has a damaged power cord or casing.
- The Vivo 40 may not work properly if any part has been dropped, damaged or submerged in water.
- To avoid electrical shock, disconnect the electrical supply to the Vivo 40 before cleaning. Do not immerse the Vivo 40 into any fluids.
- The operator shall not touch accessible contacts of connectors and the patient simultaneously.
- When handling the HA 01 humidifier, always turn off the Vivo 40 and disconnect the Vivo 40 from the AC power supply.
- Accessory equipment connected to the analog and digital interfaces must be certified according to the respective IEC standards (e.g. IEC 60950 for data processing equipment and IEC 60601-1 for medical equipment). Furthermore, all configurations shall comply with the valid version of the system standard IEC 60601-1-1. Therefore, everyone who connects additional equipment to the signal input part or signal output part configures a medical system is responsible that the system complies with the requirements of the valid version of the system standard IEC 60601-1-1. If in doubt, consult the technical service department or your local representative.



- If an external battery is used, always disconnect it when the Vivo 40 is switched off. Otherwise there is a risk that the battery will discharge.
- If the AC power source fails and the internal or the external battery activates, the HA 01 humidifier will be turned off automatically. It must be activated again manually, if humidification during battery use is necessary.
- Only use the data connection to connect the Vivo 40 to the iCom or a PC.

## 2.3 Environmental Conditions



- Do not use the Vivo 40 in any toxic environment.
- Do not use the Vivo 40 in environments where there are explosive gases or other flammable anesthetic agents present.
- The air flow for breathing produced by the Vivo 40 can be as much as 10°F (5°C) higher than room temperature. Caution should be exercised if the room temperature is greater than 95°F (35°C).
- If a room humidifier is used, place it at least 6 feet (2 meters) away from the Vivo 40.
- The performance of the Vivo 40 may deteriorate at ambient temperatures below 41°F (5°C) and above 100°F (38°C).



- Do not use the Vivo 40 while positioned in a warm place, such as direct sunlight.
- The device complies with the EMC requirements of standards. Measures should include but not be limited to:
  - normal precautions with regard to relative humidity and conductive characteristics of clothing in order to minimize the build-up of electrostatic charges.
  - avoiding the use of radio emitting devices closer than 1 m to the Vivo 40. Examples include: radio emitting devices such as cellular or cordless telephones, microwave ovens and high-frequency surgery apparatus.
- The Vivo 40, all accessories and replacement parts must be disposed of in accordance with the local environmental regulations regarding the disposal of used equipment and waste.
- The performance of the Vivo 40 and treatment of the patient may deteriorate if the operation conditions in “Technical Specifications” on page 63 are not fulfilled. Do not use the Vivo 40 immediately after storage or transport outside the recommended operating conditions.

## 2.4 Usage of Patient Circuit



- Only use the Vivo 40 with a mask, patient tube and leakage port recommended by Breas Medical AB and your health care professional.
- The Vivo 40 requires an intentional leak port instead of an actively controlled exhalation valve to remove exhaled gases from the patient circuit. Therefore, specific masks and patient circuits using an intentional leakage are required for normal operation. The pressurized air from the Vivo 40 causes a continuous flow of air to exhaust from the leak ports, flushing exhaled gas from the circuit. The Vivo 40 should be turned on and the intentional leak ports should be checked before application.
- Do not breathe in the connected patient circuit unless the Vivo 40 is turned on and operating properly.
- Do not use patient hoses or tubes made of static or electrically conductive material.
- Patient connected parts and filter must be replaced regularly to ensure correct function of the Vivo 40. All replaced parts must be disposed of according to local environmental regulations regarding the disposal of used equipment and parts.
- Periodically check for moisture in the patient circuit. When present, remove the moisture. Before attempting to dry the circuit, disconnect it from the Vivo 40 to ensure no water will flow back into the Vivo 40.
- If the patient needs assistance to take off the patient interface, the patient shall not be left alone. This is to avoid the risk of re-breathing of CO<sub>2</sub> in case of accidental ventilator failure. If the patient is using a full face mask (covering mouth and nose), the mask must be equipped with a safety entrainment valve.

- Make sure that the ventilation holes in the mask or the leakage ports are never blocked or obstructed. These ports are used to prevent re-breathing of exhaled air. Re-breathing of exhaled gases for longer than several minutes can, in some circumstances, lead to suffocation.
- At low CPAP pressures, the air flow through the ventilation holes in the mask or the leakage ports may be inadequate to clear all exhaled gases. Some re-breathing may occur.
- Do not leave long lengths of air tubing around the top of the bed. It could twist around the patient's head or neck while sleeping.
- Always follow the instructions of the mask manufacturer.

## 2.5 Invasive Use



- For invasive applications, assure that an intentional leakage port is present in the patient circuit. Install the leakage port as close as possible to the patient connection, to reduce the risk of rebreathing CO<sub>2</sub>.
- When using the Vivo 40 invasively the low volume alarm and the low breath rate alarm must be carefully set, to ensure safe use.
- The highest output from the HA 01 humidifier is 30 mgH<sub>2</sub>O/litre, which means that it does not fulfill the humidifier standard for invasive use.
- The Vivo 40 is equipped with a low leakage alarm. The low leakage alarm is not a substitute for operator vigilance in ensuring that the leakage ports remains clear at all times. Periodically check the leakage ports during therapy.
- In general as pressure decreases the potential of rebreathing increases. Lower pressures produce less flow through the leakage ports which may not clear all CO<sub>2</sub> from the circuit to prevent rebreathing.
- In general as inspiratory time increases the potential of CO<sub>2</sub> rebreathing increases. A higher inspiratory time decreases the expiratory time allowing less CO<sub>2</sub> to be cleared from the circuit before the next breath. I:E (inspiration time : expiration time) ratios close to 1:1 increase the potential of CO<sub>2</sub> rebreathing.
- Tracheal tubes, oral/nasal tubes etc with small inner diameters increase the resistance in the breathing circuit.
- An external heated humidifier approved for invasive use or an appropriate HME (Heat and Moisture Exchanger, artificial nose)/HCH (Hygroscopic Condenser Humidifier) is recommended.

## 2.6 Usage of Filters



- Always use the Vivo 40 with patient air inlet filters installed. Only use filters that are specified in this manual.
- Replace or clean the filters regularly to ensure correct function of the Vivo 40, especially when changing patient. Failure to replace or clean a dirty filter may cause the Vivo 40 to operate at higher temperatures than intended.
- When operating the Vivo 40, make sure that the air inlet and filters are not obstructed or occluded.
- The use of a high resistance bacteria filter on the output of the device may interfere with the operation of the patient disconnect function. It may also interfere with the device trigger function.
- Do not connect any filter to the HA 01 humidifier.

## 2.7 Humidification



- The HA 01 humidifier is intended for non-invasive use only.
- Humidification must only be used if this has been prescribed by your physician. The Vivo 40 therapy settings must always be prescribed by a physician or other licensed health care professional, and be carried out by authorized clinical personnel.
- Do not place the Vivo 40 with the HA 01 humidifier in a bag.
- When the HA 01 humidifier is installed, the Vivo 40 must be located below the patient and on a flat surface. This is to prevent personal injury from accidental spillage or from excess water or condensation flowing down the patient tube and into the patient's mask. Extra cautions should be taken for patients who are unable to guard their airways or cannot pull off the mask.
- When using an external heated humidifier, it should be located below the Vivo 40 and the patient to prevent injury from accidental spillage.
- If the condensation in the patient circuit is excessive, the use of a heated humidifier may require the installation of a water trap in the circuit. The water trap prevents any condensed water in the patient circuit from running into the patient airways and causing personal injury.



The use of an HME (Heat and Moisture Exchanger, artificial nose) or an external humidifier may require readjustment of the Vivo 40's low-pressure alarm.

- Certain HME's and HCH's (Hygroscopic Condenser Humidifiers) are sufficient to provide humidification when the Vivo 40 is used invasively. Check specific suppliers recommended use.

## 2.8 Cleaning and Maintenance



- The Vivo 40 should be cleaned and maintained in accordance with this operating manual.
- Do not attempt to autoclave or sterilize the Vivo 40.
- Vivo 40 should be subjected to maintenance, service and control and any applicable upgrades, in accordance with Breas service instructions.
- Vivo 40 shall only be repaired or modified in accordance with Breas service manuals, technical bulletins, and any special service instructions, by service technicians authorized by Breas Medical AB.
- Do not under any circumstances attempt to service or repair the Vivo 40 yourself. If you do so, the manufacturer will no longer be responsible for the performance and safety of the Vivo 40. Furthermore, no warranty will be valid.



## 2.9 Adverse Patient Symptoms



If the patient experiences discomfort or any of the following symptoms while using the Vivo 40, a physician or responsible clinician shall be contacted immediately:

- Bloated feeling from excessive swallowing of air while awake
- Air continually leaking from the mouth while sleeping
- Dryness of air passages or nose
- Ear pain, runny nose or sinus discomfort
- Day time sleepiness
- Disorientation or memory lapse
- Mood change or irritability
- Skin sensitivity
- Severe headache
- Chest discomfort
- Shortness of breath

The following are potential side effects of non-invasive positive pressure therapy:

- Ear discomfort
- Conjunctivitis
- Skin abrasions due to non-invasive interfaces
- Aero phagia (gastric distension)

## 2.10 Usage of Oxygen



- The presence of oxygen can speed up combustion of inflammable materials.
- If oxygen has been prescribed, connect the oxygen supply tube to the appropriate oxygen port of the nasal mask or breathing system connector.
- At a fixed flow rate of supplemental oxygen flow, the inhaled oxygen concentration will vary, depending on the pressure delivered, patient's breathing pattern, mask selection, and leak rate.
- When oxygen is used with the Vivo 40, the oxygen flow must be turned off when the Vivo 40 is not operating.
- Ventilate the room adequately.
- Do not smoke in a room where oxygen is being used.
- Naked light bulbs and other sources of ignition must be kept a minimum of 6 feet (2 meters) away from the oxygen cylinder or any part of the patient circuit.
- Do not use aerosols or solvents close to the oxygen supply, even when the oxygen supply is shut off.
- When the Vivo 40 is not in operation, and the oxygen flow is left on, oxygen delivered into the patient tubing may accumulate within the machine enclosure. Oxygen accumulated in the machine enclosure will create a risk of fire.



- Supplemental oxygen may trigger the low leakage alarm prematurely.
- Supplemental oxygen flow may not exceed 15 liter/min.
- Supplemental oxygen affects the accuracy of the volume and flow measurements. It is not recommended to use supplemental oxygen when target volume is active.



# 3 Product Description

## 3.1 Main Components

The Vivo 40 system contains the following components:

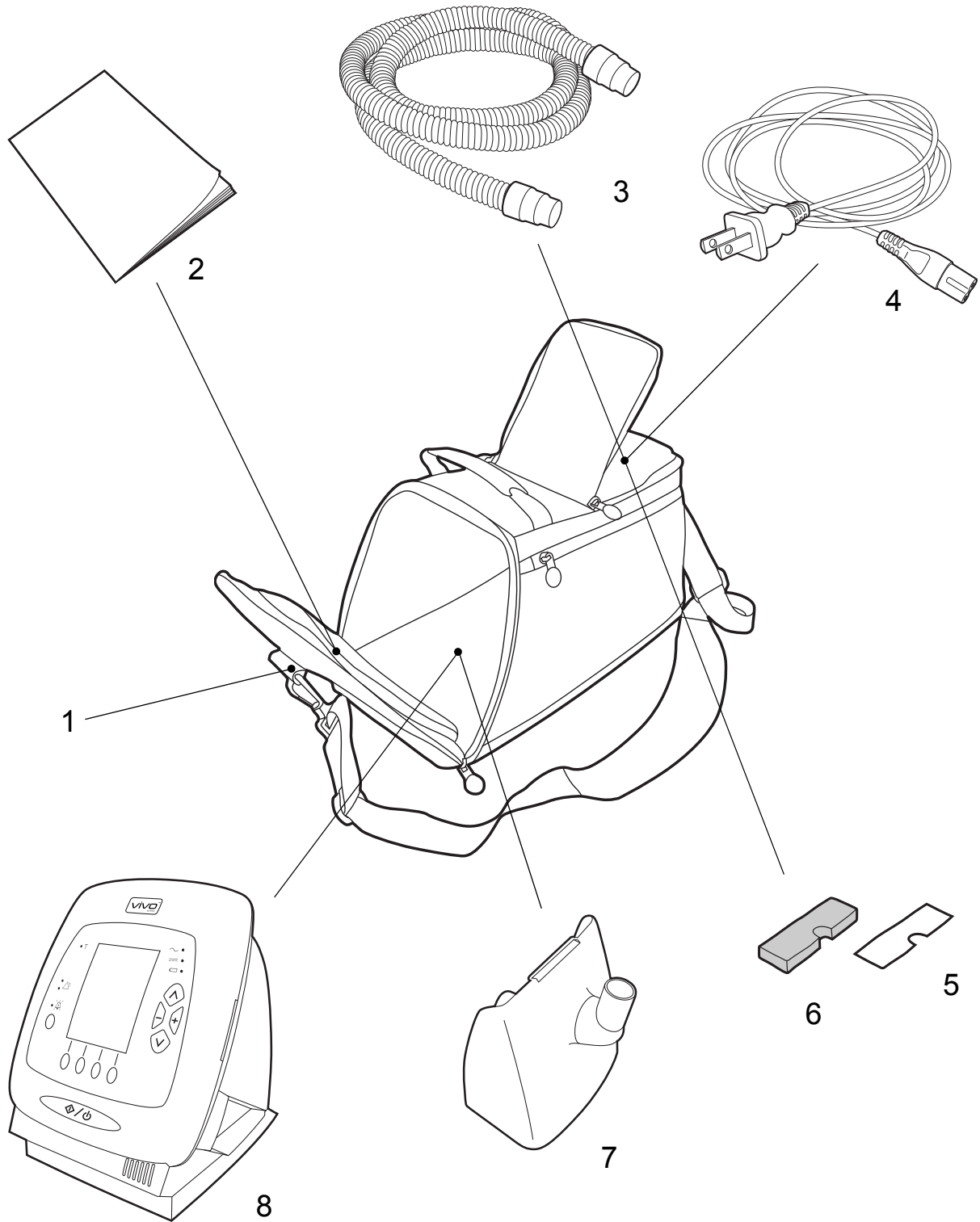

<b>No.</b>	<b>COMPONENT</b>	<b>FUNCTION</b>	<b>PART NO.</b>
1	Carry bag	Storage for transportation	003519
2	User manual	Product and usage information	003819
3	Patient tube		004465
4	Power cord		003522
5	Filter (white, disposable)	Inlet air filtration	003526
6	Filter (grey, washable)	Inlet air filtration	003527
7	Rear lid	For usage without the HA 01 humidifier	003591
8	Vivo 40 main unit		

## 3.2 Accessories

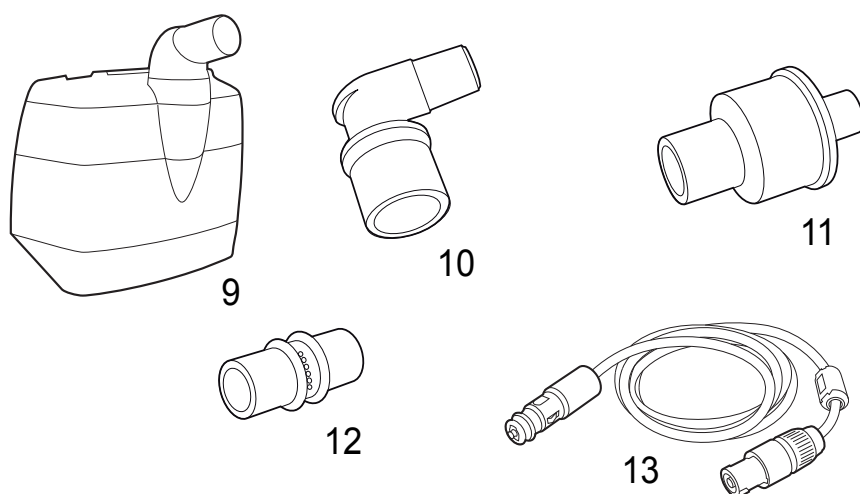

No.	COMPONENT	FUNCTION	PART NO.
9	HA 01 Humidifier	Humidifies patient air	003530
10	Trach elbow	Trach connection	004810
11	Hygroscopic Condenser Humidifier (HCH)	Humidifier	003974
12	Leakage/Exhalation port	Providing a leakage	004426
13	Battery cable 12/24 V DC		004258

### 3.3 The Vivo 40's Front Panel

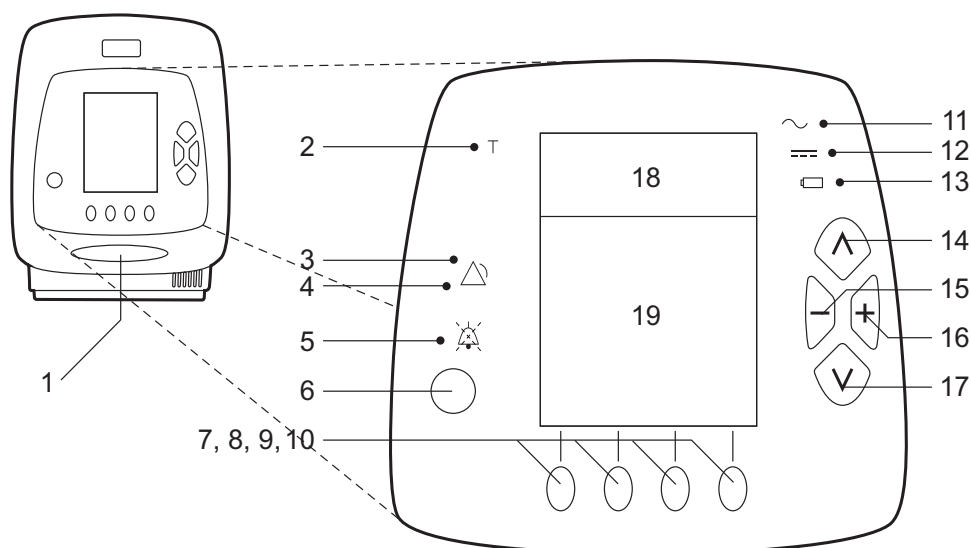

No.	USER BUTTONS	FUNCTION
1	Start/Stop	Start/Stop ventilation treatment
6	Audio pause	Pause the alarm sound
7-10	Function/Navigation	Function according to display
14-17	Navigation/Setting	Navigation in current menu selection/ Define settings

No.	LED	FUNCTION
2	Trigger	Patient breath trigger indication
3-4	Alarm (red & yellow)	Alarm indication
5	Audio pause	Paused alarm sound indication
11	AC power	Power source: AC power
12	External DC	Power source: External DC
13	Internal battery	Power source: Internal battery

No.	DISPLAY WINDOW	FUNCTION
18	Monitoring section	Current treatment data
19	Active section	Adjustable settings

### 3.4 The Vivo 40's Back and Side Panels

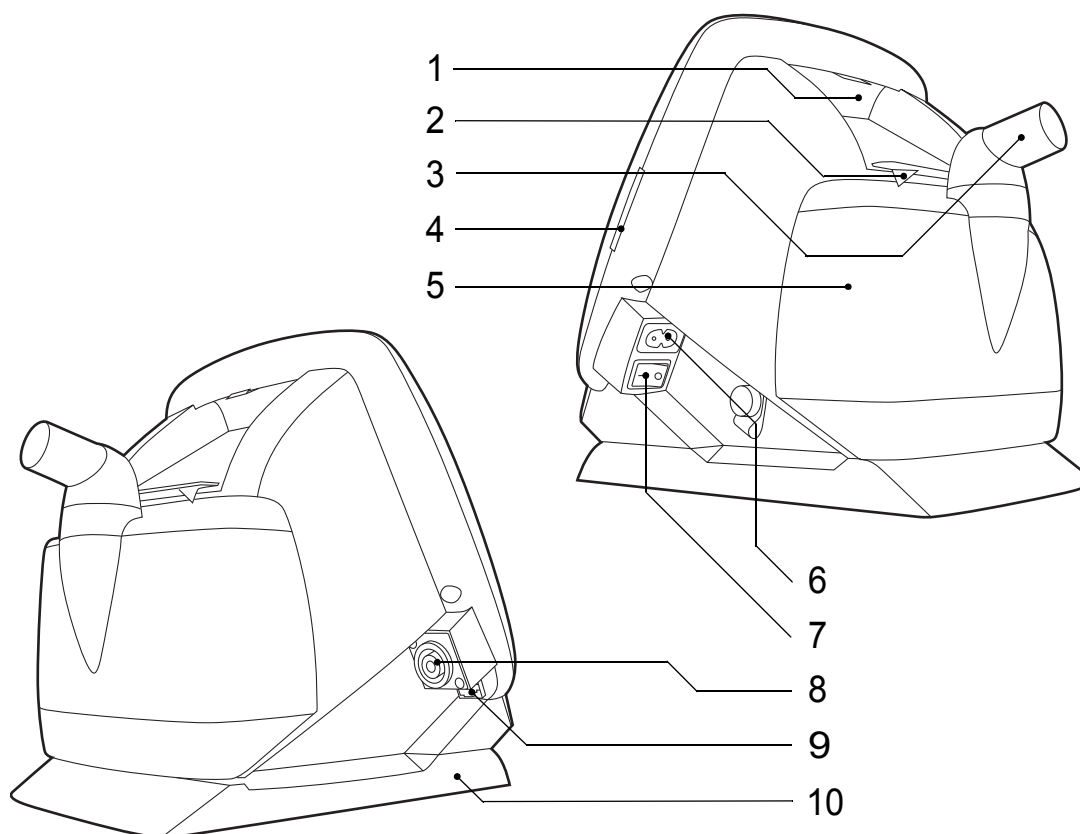

No.	ITEM	FUNCTION
1	Air inlet	Air path in, replaceable filters
2	Locking mechanism	Release and lock the HA 01 humidifier or rear lid
3	Air outlet	Air path out to the patient
4	Memory card slot	Read and write memory card
5	HA 01 humidifier	Patient air humidification
6	AC power inlet	Connection for an external AC power source
7	On/Off	AC power on and off
8	External DC inlet	External DC power source connection
9	Data connection	Data cable connection (iCom/PC and the Vivo 40)
10	Internal battery	Provides power for a limited time in case of AC power disconnect



### 3.5 Equipment Designation and Safety Label

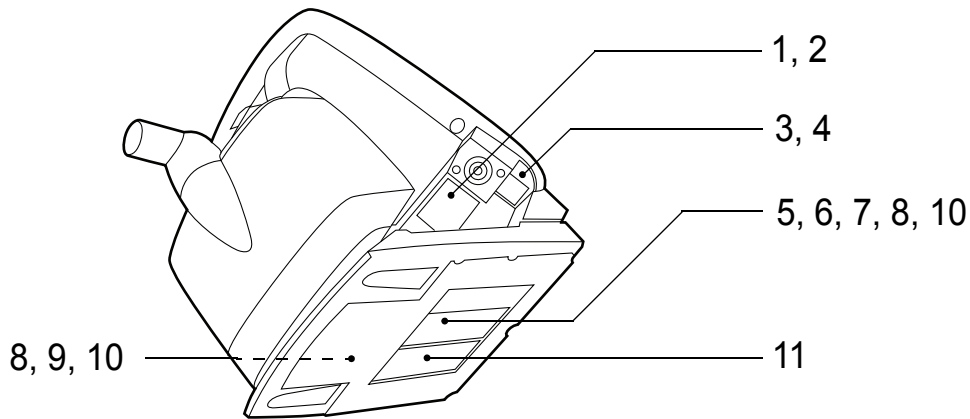

No.	SYMBOL	EXPLANATION
1		Model designation
2		Serial number (last seven alphanumeric characters)
3		Data connection port (for iCom or PC)
4		The data connection port is only to be used by your care provider.
5		Class II electrical equipment; double insulation
6		Body floating (IEC 60601-1 Type BF, Isolated Applied Part)
7		Read the user manual thoroughly before using the Vivo 40.
8		CE marking applies in accordance with the directive MDD 93/42/EEC.
9		Before using the internal battery, read “Using Batteries” on page 36 carefully.
10		Read “Disposal” on page 62 for information about recycling and disposal.
11		Battery instructions

## 4 Functions and Parameters of the Vivo 40

This chapter includes descriptions of the modes and parameters used for controlling the ventilation of the Vivo 40.

### 4.1 Ventilation Mode

The following modes can be selected for the Vivo 40:

- PCV mode (Pressure Control Ventilation)
- PSV mode (Pressure Support Ventilation)
- CPAP mode (Continuous Positive Airway Pressure)

### 4.2 Settings

#### The Ramp Function (optional)

The ramp function is used for increasing the EPAP and IPAP pressure during a set time, the IPAP pressure starts at 2 cmH<sub>2</sub>O above the ramp start pressure.

During CPAP mode the ramp function provides a pressure increase from the ramp start pressure to the set CPAP pressure during a set time.

### 4.3 Standby and Operating Mode

Standby mode is defined as the state of the Vivo 40 when AC power is connected and the On/Off switch is on, but without starting the Vivo 40 with the Start/Stop button.

Operating mode is defined as the state of the Vivo 40 when the fan is operating and producing an air flow.

Enter operating mode by switching the Vivo 40 on (see “Switching the Vivo 40 On and Off” on page 29). Enter standby mode by switching the Vivo 40 off again.

Some operations such as accessing the memory card and setting time and date are only available in standby mode.

## 4.4 Low Leakage Detection

The Vivo 40 automatically detects if the mask and tubing fitted to the device has sufficient leakage. If the leakage measured is below the recommended level it will generate a Low Leakage Alarm. The Vivo 40 will continue to deliver breaths during the alarm.



Check mask, leakage/exhalation port and tubing and if necessary clean ventilation holes if clogged.

## 4.5 Humidifier (optional)

The humidifier function is adjustable to provide additional humidity to the patient air.

## 5 Using the Vivo 40

### 5.1 Set up the Vivo 40 Before Use

Always do the following before using the Vivo 40:

- 1 Connect a cleaned or new patient circuit to the Vivo 40.
- 2 Connect the Vivo 40 to the AC power source.
- 3 Switch on the Vivo 40 main power using the On/Off switch on the side panel.
- 4 Press the Start/Stop button on the front panel. Check that a short sound signal is heard. If there is no signal, do not use the Vivo 40 and contact your service provider.
- 5 Ensure that the settings are adjusted as prescribed.

The Vivo 40 is ready for use.

## 5.2 Switching the Vivo 40 On and Off

### Switching On

**1** Make sure the AC power source is connected and the On/Off switch is switched on.

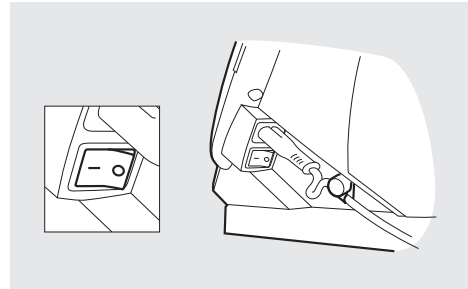

**2** Turn on the Vivo 40 by pressing the Start/Stop button on the front panel for 2 seconds. Press for 4 seconds when using an external or internal battery. A short sound signal is heard.

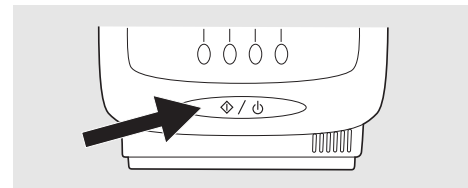

### Switching Off

**1** Press the Start/Stop button on the front panel for 2 seconds (max 4 seconds).

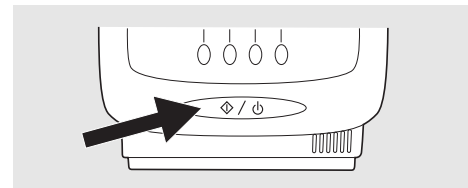

**2** Release the Start/Stop button when the message is shown in the display window.

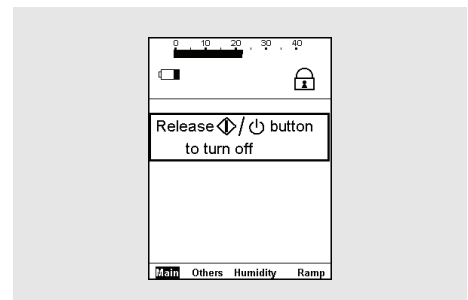

**3** Turn off the Vivo 40 by pressing the Start/Stop button again.

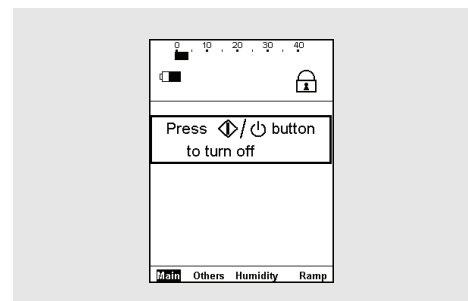

## 5.3 Using the Menu

Use the four navigation buttons and the up, down, “+” and “-” buttons on the front panel to navigate the Vivo 40 menu.

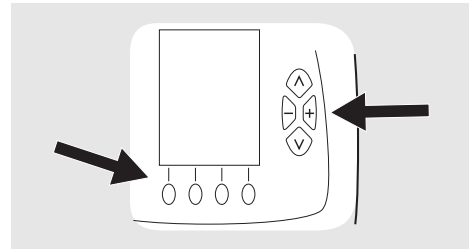

Read chapter “The Vivo 40’s Front Panel” on page 23 for exact position of the buttons.

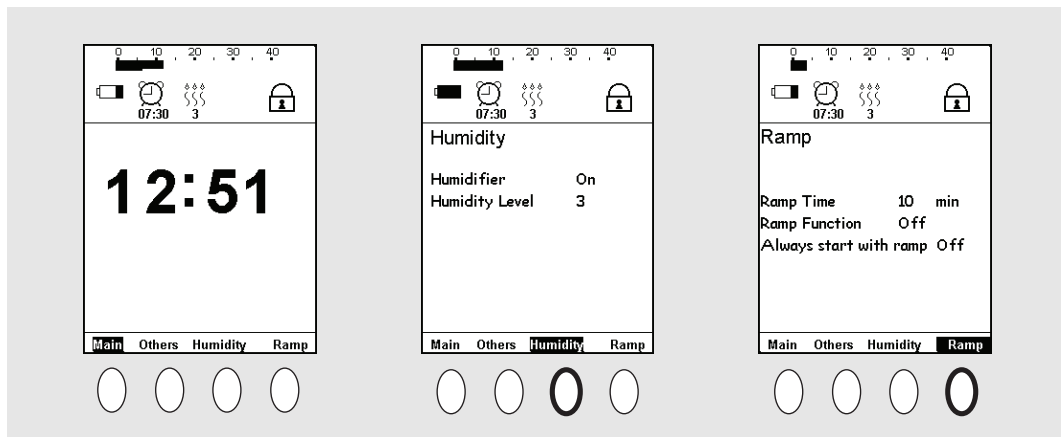

The navigation buttons are used to view the different sections defined above each navigation button. The same navigation button can also be used to view additional information in some sections.







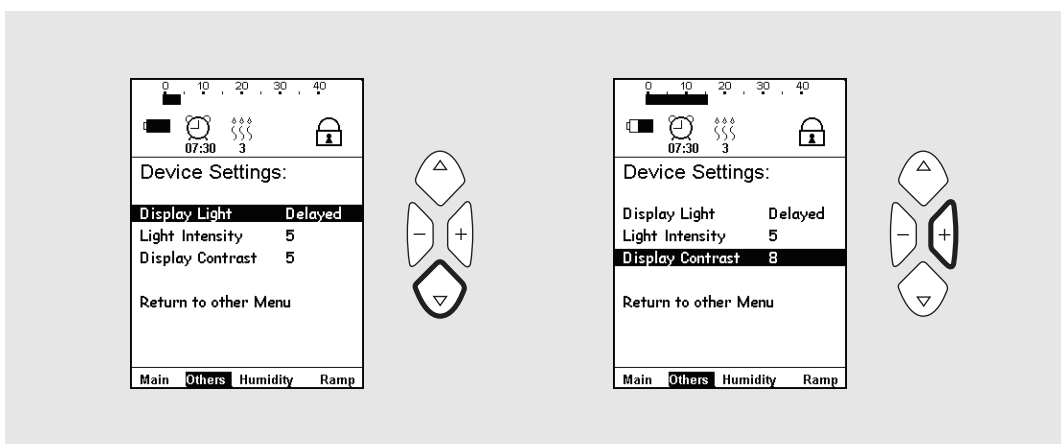

Use the up or down button to enter the menu list.

During operation and when no button has been pressed for 20 seconds, the menu will automatically switch to the clock.



The up and down buttons are used to select values in a section. The plus and minus buttons are used to alter a value.

## Symbols Used in the Menu

SYMBOL	DESCRIPTION	UNIT
	Battery level	
	Alarm time active	Hour : Minute
	HA 01 humidifier active	1 to 9, Off
	Ramp active	Minute
	Panel locked	On, Off
	Panel locked by the Breas Vivo PC software	On, Off

## Overview

The Vivo 40 menu has the following section layout:

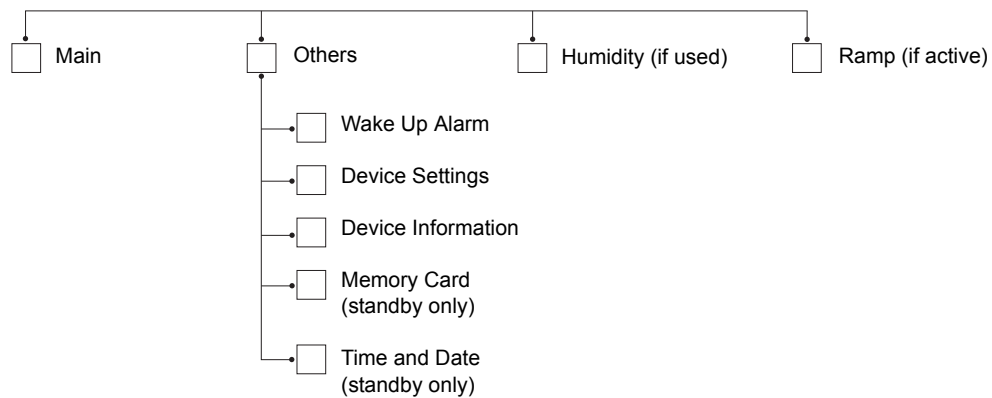



## Main Menu

The monitoring section contains a bargraph to display the current pressure. Further, information about the alarm time, HA 20 humidifier, remaining ramp time and the panel lock is shown.

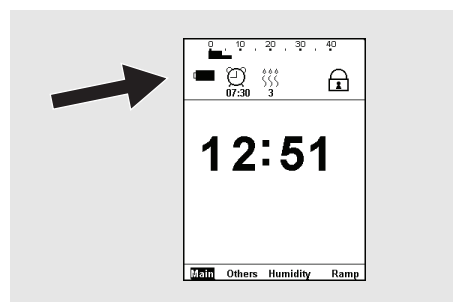

## The Others Menu

The menu list for “Others” in standby mode (with HA 01 humidifier connected).

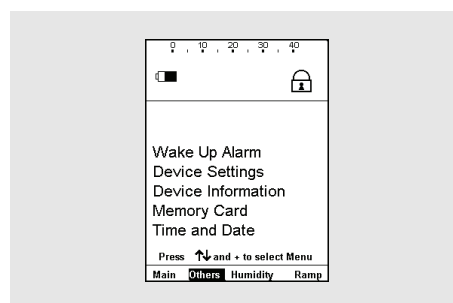

The menu list for “Others” in operating mode.

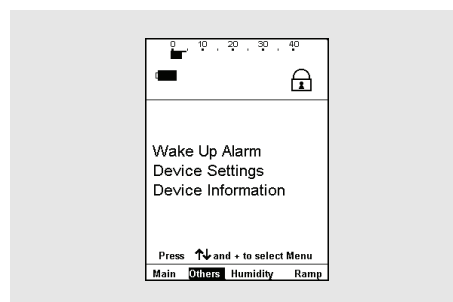

## Wake up Alarm

Navigate to the section “Others” and select “Wake up Alarm” to reach the “Wake up Alarm” page.

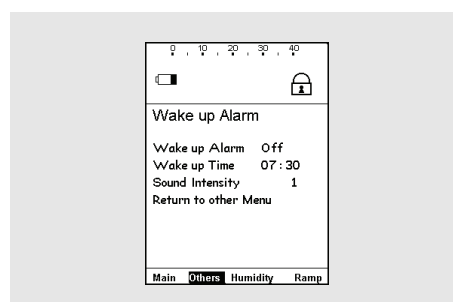

## Device Settings

Navigate to the section “Others” and select “Device Settings” to reach the “Device Settings” page.

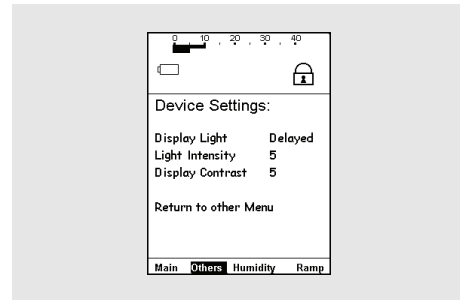

## Device Information

Navigate to the section “Others” and select “Device Information” to reach the “Device Information” page.

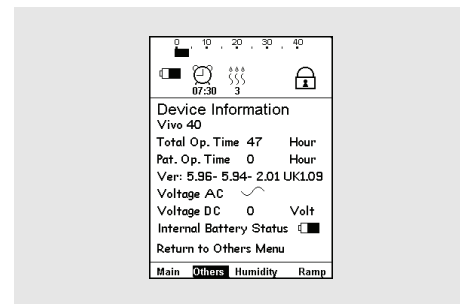

## Time and Date

Navigate to the section “Others” and select “Time and Date” to reach the “Time and Date” page.

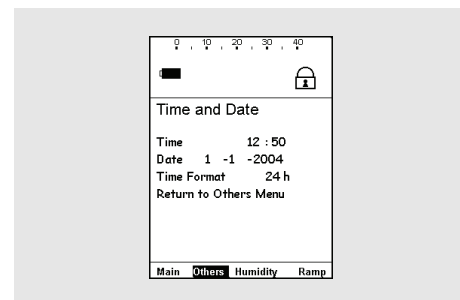

## 5.4 Monitoring Section

The monitoring section provides a display of the current treatment data. The monitoring section is located in the top of the display window:

The monitoring section contains a bargraph, information about the alarm time, HA 01 humidifier, remaining ramp time, battery status and the panel lock is shown.

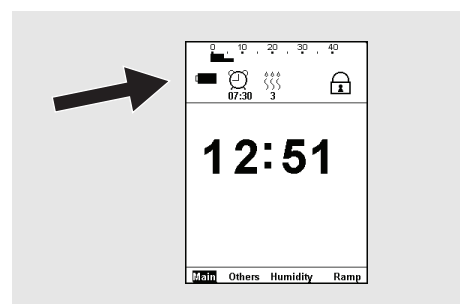

## 5.5 Using the HA 01 Humidifier



*Information about safety, warnings, product description, installation, usage, cleaning, maintenance and technical specifications can be found in the Breas HA 01 Humidifier User manual.*



Read the chapter “Humidification” on page 15 carefully to make sure all conditions are fulfilled and considered.



If the AC power source fails and the internal or the external battery activates, the HA 01 humidifier will be turned off automatically. It must be activated again manually, if humidification during battery use is necessary.

The HA 01 humidifier is intended to humidify the patient air. The HA 20 humidifier must be installed in order to access and navigate to the humidifier setting on the Vivo 40 menu. The HA 01 humidifier can only be activated if the Vivo 40 is operating.

Navigate to the “Humidity” page. The humidity setting range from 1 to 9, where 9 generates the maximum humidity.

Always set the humidity control to the setting recommended by your doctor.

The HA 20 humidifier can be activated and deactivated by pressing the humidifier soft key for more than 1 second.

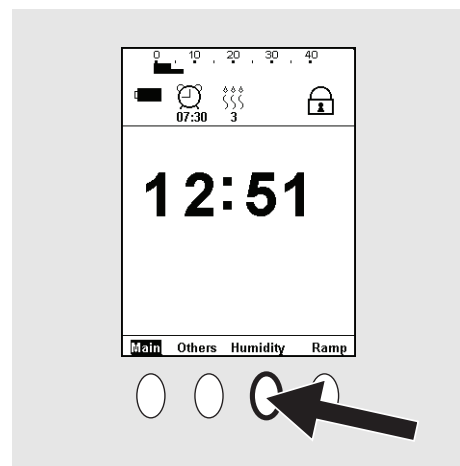
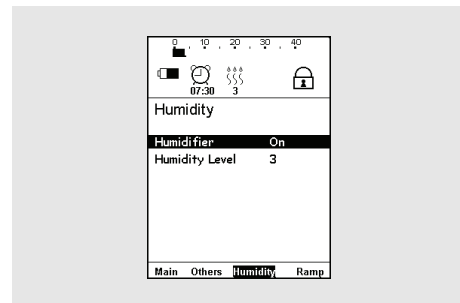

If the HA 01 humidifier is disconnected and reconnected after usage according to the instructions in the HA 01 Humidifier User manual, the Vivo 40 will remember the humidity setting used.

## 5.6 Using Batteries





A battery is intended as a backup power source if the primary AC power source fails.

### Power Source Priority

- 1 AC power
- 2 External DC
- 3 Internal battery

When a power source fails, the Vivo 40 will switch to either the internal or the external battery if installed and show a message in the display window.

When running on battery, the battery status is indicated by the following symbols:

	Full
	Medium
	Low
	Empty
	The internal battery is disconnected or malfunctioning.



Using the HA 01 humidifier while operating on a battery significantly decreases the battery operation time.

### Internal Battery

The internal battery can also be used as a temporary power source for transportation between one stationary power source to another.



**Due to the internal battery, the Vivo 40 may start if the Start/Stop button is pressed accidentally, for instance, when packing the ventilator in the carry bag. Make sure to place and pack the device in a way that prevents unintentional start of the machine.**

The battery level is displayed in the monitoring section. The estimated internal battery capacity is only shown when the Vivo 40 is operating from the internal battery. This display is for indication only.

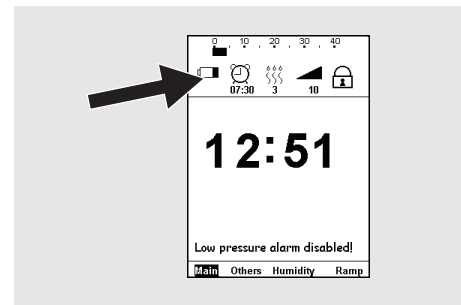

## Charging the Internal Battery

Each time the Vivo 40 is connected to the AC power supply and the On/Off switch is switched on (standby mode), the Vivo 40 will automatically start a 10-hour charging cycle of the internal battery. This is indicated by a flashing battery indicator in the display. This is done regardless of the internal battery charging status.

To recharge an empty internal battery takes about 14 hours in standby mode. The charging is reduced by 50% during operation. If the temperature inside the Vivo 40 is higher than 113°F (45°C), which is normal during operation, the charging is decreased in order to protect the battery. This will result in longer battery charging time.

Follow the instructions below to ensure that the battery capacity of the Vivo 40 is maximized during its lifetime:

- Exercise the battery every 3 months by discharging it completely and fully recharging it again. Repeat this procedure twice.
- If the Vivo 40 is stored for more than 1 month, connect it to the AC power supply to recharge the internal battery and alarm battery.
- Replace the internal battery every 24 months, after 500 charging cycles, or when necessary to ensure the battery performance.

## Internal Battery Operation Time

The internal battery operation time is dependent on the battery condition, its capacity, the ambient air temperature and the Vivo 40 settings.

The following are examples of the operation time with new, fully charged batteries and Vivo 40 running in PCV mode:

<b>SETTING</b>	<b>VALUES</b>		
EPAP	4	8	4
IPAP	10	20	30
Breath Rate	12	15	20
Insp. Time	2.0	1.5	1.5
Rise Time	3	3	1
Insp. Trigger	Off	Off	Off
Delivered Tidal Volume	0.20	0.50	0.75
<b>Total Time</b>	<b>4 h</b>	<b>2 h 45 min</b>	<b>1 h 45 min</b>

<b>ENVIRONMENTAL CONDITIONS</b>	
Ambient temperature	68°F (20°C)
Altitude	Sea level

### **External Battery**

The Vivo 40 can be operated from a 12 V or a 24 V DC external battery.

- Use the battery cable 12/24 V DC and check carefully that the voltage is 12 V or 24 V.
- Check the polarity of the external battery before connecting it to the Vivo 40.

With an external battery connected, the Vivo 40 will automatically switch over to the external battery source if the AC power cord is removed or if the AC power supply fails. The external DC level is shown under “Others, Device information” in the menu.

- 1 Connect the external DC cable to the Vivo 40. Make sure that it is fitted correctly.
- 2 Connect the other end of the cable to the battery source.

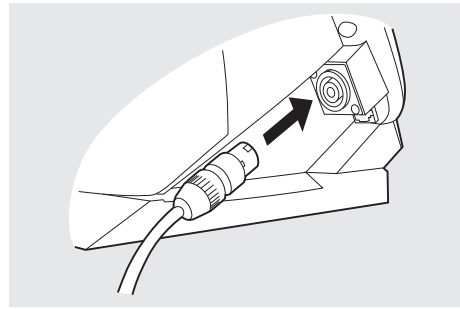

- Only use a Breas external DC cable to connect the Vivo 40 to the external battery.
- An external battery must be disconnected when the Vivo 40 is switched off, otherwise the battery can be discharged.

### External Battery Operation Time

The operation time is dependent on the battery condition, its capacity, the ambient air temperature and the Vivo 40 settings.

## 5.7 Vivo 40 Operating Time

The Vivo 40 records two types of operating times. They can be viewed on the page “Device Information” in the “Others” section.

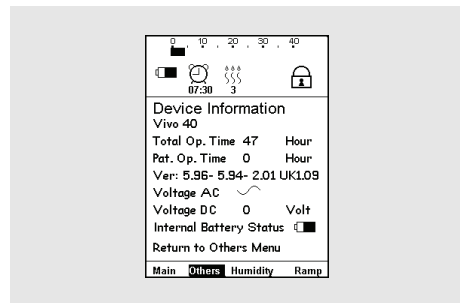

### Total Operating Time

Shows the total number of hours the Vivo 40 have been operating.

### Patient Operating Time

Shows the total number of hours a patient have been using the Vivo 40 for breathing therapy.

## 6 Preparing the Vivo 40 for Use



Read the chapter “Safety Information” on page 8 before setting up and using the Vivo 40.

### 6.1 Installing the Vivo 40

When using the Vivo 40 for the first time, follow the instructions below:

**1** Check that all main components and ordered accessories have been delivered (refer to the packing note or the invoice, if available).

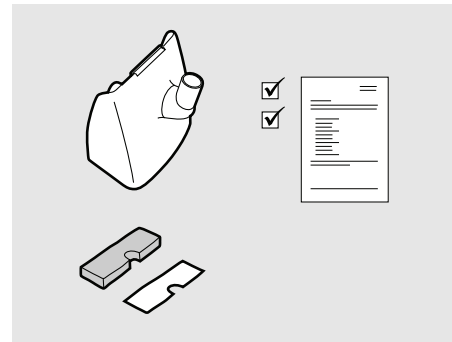

**2** Ensure that the equipment is in good condition.

**3** If stored more than 1 month, connect the Vivo 40 to the AC power supply and switch on the On/Off switch to recharge the internal battery and the alarm battery in standby mode.

**4** Check that the air filters are installed.

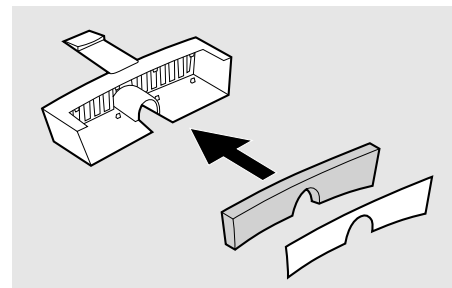



## 6.2 Placing the Vivo 40



Read the chapter “Environmental Conditions” on page 11 carefully to make sure all conditions are fulfilled and considered.

1 Place the Vivo 40 on a solid, flat surface facing towards the patient. The Vivo 40 should be placed lower than the patient in order to prevent the device from falling on the patient, as well as preventing condensed water to reach the patient.

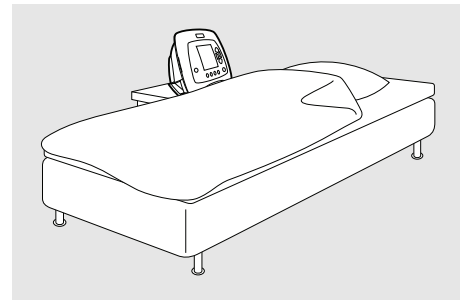

2 Make sure that nothing can block the patient air inlet at the rear of the Vivo 40.



## 6.3 Connecting the Vivo 40 to the AC Power Source



Read the chapter “Electrical Safety” on page 10 carefully to make sure all conditions are fulfilled and considered.

**To connect the Vivo 40 to the AC Power Source:**

1 Plug the power cord into the power inlet of the Vivo 40.

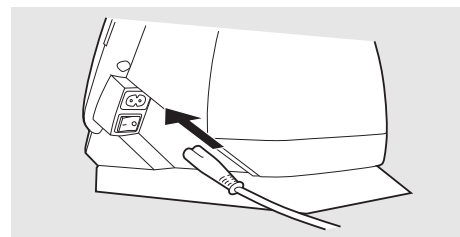

2 Create a small loop on the cable in order to prevent stretching. Secure the power cord using the cable holder.

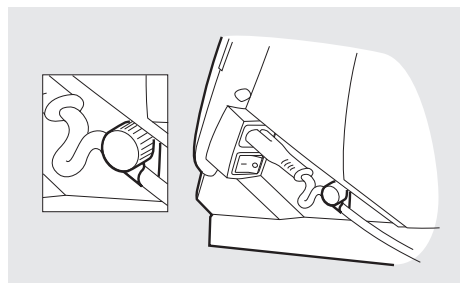

**3** Connect the power cord to the AC power source.

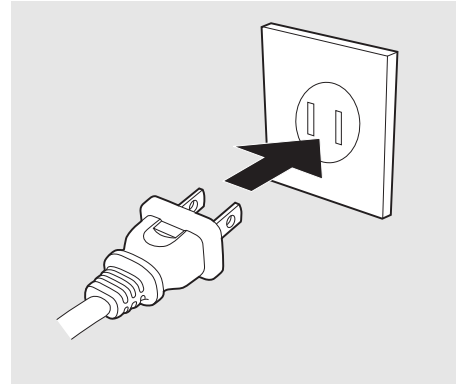

## 6.4 Connecting the Patient Circuit



Read the chapter “Usage of Patient Circuit” on page 12 carefully to make sure all conditions are fulfilled and considered.

### Non-Invasive Use

1 Connect the patient tube to the air outlet.

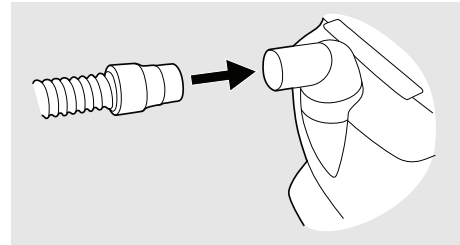

2 Connect the other end of the patient tube to the mask and the leakage port, if applicable.

### Invasive Use

1 Connect the patient tube to the air outlet.

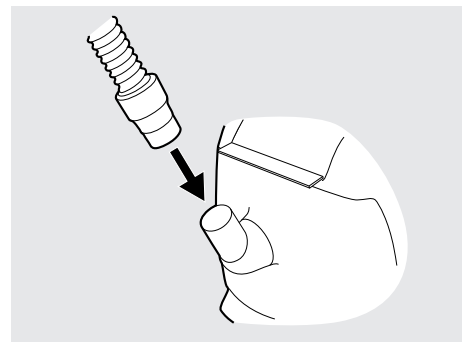

2 Connect the other end of the patient tube to the leakage port, a hygroscopic condenser humidifier (HCH) and a trach elbow.

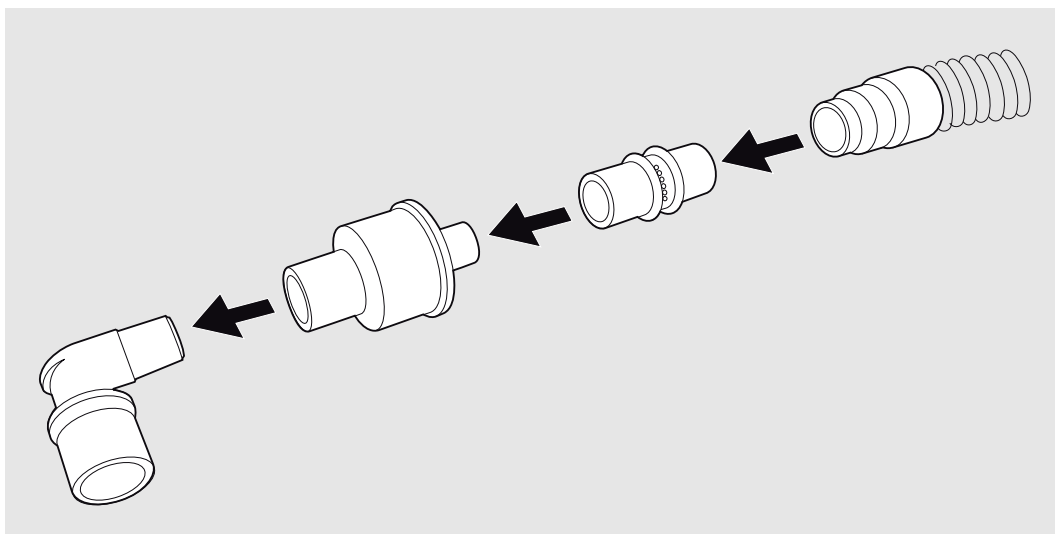

### Intentional Leakage

The leakage from the mask or leakage/exhalation port should be at least 12 liter/min at 4 cmH<sub>2</sub>O, to prevent re-breathing of exhaled air. The recommended mask leakage is 20 to 40 liter/min at 10 cmH<sub>2</sub>O pressure.

This leakage may be achieved by:

- integrated leakage in the mask
- an adjoining leakage port

## 7 Alarms



The adjustable alarm settings should be re-evaluated whenever a change in settings is made on the Vivo 40.

This chapter describes the alarm functions used for the Vivo 40.

### 7.1 Alarm Function

The alarm function of the Vivo 40 consists of the alarm LEDs on the front panel, an audible alarm, and messages on the LCD display (see “The Vivo 40’s Front Panel” on page 23 for an overview of the position of the LEDs and the LCD display).

#### Alarm Indication



As soon as an alarm condition is set, the Vivo 40 will alarm without delay.

When an alarm condition arises the alarm is indicated in three ways:

- Color LED on the panel: indicates the priority of the active alarm condition.
  - High priority: Red color, flashing twice per second.
  - Medium priority: Yellow color, flashing every 2 seconds.
- Alarm text in display: displays the name of the active alarm condition.

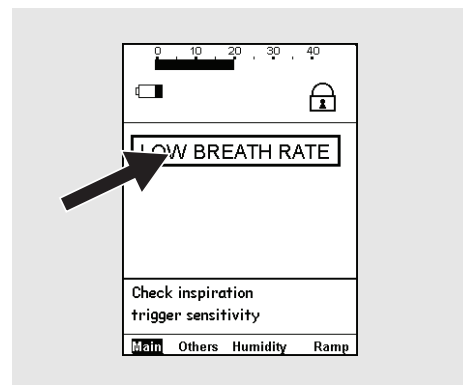
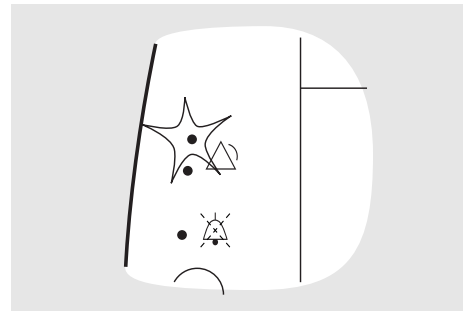

- Audible signals: indicates the priority of the active alarm condition.
  - High priority: 3 signals followed by 2 more. The signal sequence is repeated after a 0.5 seconds pause.
  - Medium priority: 3 signals only, with a lower frequency than the high priority alarm. The signal sequence is repeated after a 6 seconds pause.
  - Function failure. Same signal as the high priority alarm or a constant signal, depending on the kind of function failure.

### Audible Signal Pause and Reactivation

The audible signal can be paused by pressing the Audio Pause button. If the ventilator still registers the same alarm after 60 seconds, and the Audio Pause button was pressed, the audible signal will sound again.

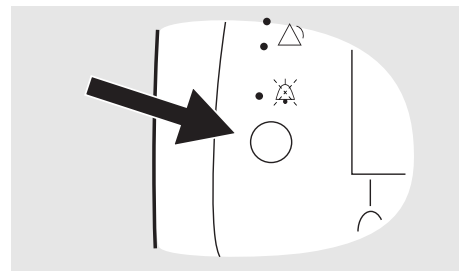

Once the audible signal has been paused, it can be reactivated by pressing the Audio Pause button again for 2 seconds.

If a new alarm condition occur during the silence period, the audible signal will be reactivated.



**To ensure the timely detection of any new alarm condition, never leave a patient unattended while the audible signal is paused.**

### Alarm Reset

An alarm will automatically be reset once the cause of the alarm has been corrected.



**If an alarm condition cannot be corrected, discontinue use and refer the Vivo 40 for service.**

## 7.2 Physiological Alarm

### Low Pressure Alarm

ITEM	DESCRIPTION
<b>Definition</b>	A low pressure alarm will be given when the Vivo 40's pressure fails to reach the low pressure alarm limit for 15 seconds.
<b>Possible cause</b>	<ul style="list-style-type: none"><li>• Disconnection of patient circuit.</li><li>• Setting is higher than IPAP/IPAPmin.</li><li>• Leakage from the mask or other components of the patient circuit.</li></ul>
<b>Ventilator action</b>	The Vivo 40 will continue to give breaths with the same settings.

#### Indication

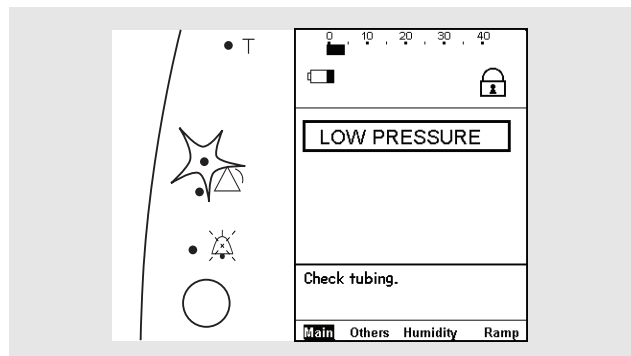

The alarm is given audibly with a tone and visibly by the red alarm LED and a display message.

## High Pressure Alarm

ITEM	DESCRIPTION
<b>Definition</b>	A high pressure alarm will be given when the Vivo 40's pressure exceeds 10 cmH <sub>2</sub> O more than IPAP/IPAPmax, for 3 consecutive breaths.
<b>Possible cause</b>	Only activated under exceptional conditions, such as a strong cough during the ventilator's inspiration phase.
<b>Ventilator action</b>	The Vivo 40 will terminate inspiration from the first high pressure breath. The Vivo 40 will then continue to give breaths with same settings.

### Indication

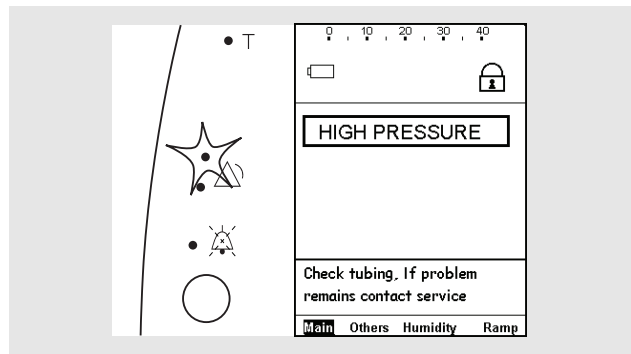

The alarm is given audibly and visibly by the red alarm LED and a display message.



## Low Volume Alarm

ITEM	DESCRIPTION
<b>Definition</b>	A low volume alarm will be given when the Vivo 40's volume fails to reach the low volume alarm limit for 15 seconds (45 seconds after start-up and after cancelling a high leakage alarm).
<b>Possible cause</b>	<ul style="list-style-type: none"><li>• Restrictions in airways.</li><li>• Obstructed or occluded patient circuit.</li></ul>
<b>Ventilator action</b>	The Vivo 40 will continue to give breaths with the same settings.

### Indication

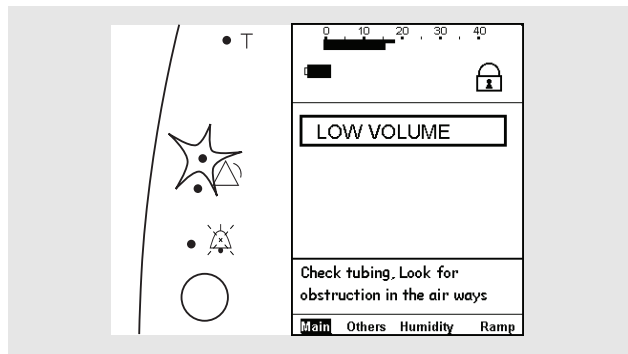

The alarm is given audibly with a tone and visibly by the red alarm LED and a display message.

## Low Breath Rate Alarm (Apnea alarm)

ITEM	DESCRIPTION
<b>Definition</b>	A low breath rate alarm will be given when the delivered breath rate is less than the low breath rate alarm limit for 15 seconds.
<b>Possible cause</b>	<ul style="list-style-type: none"><li>• Setting is higher than breath rate.</li><li>• The patient doesn't trigger any breaths.</li><li>• Decrease of the patient's spontaneous breathing.</li></ul>
<b>Ventilator action</b>	The Vivo 40 will continue to give breaths with the same settings.

### Indication

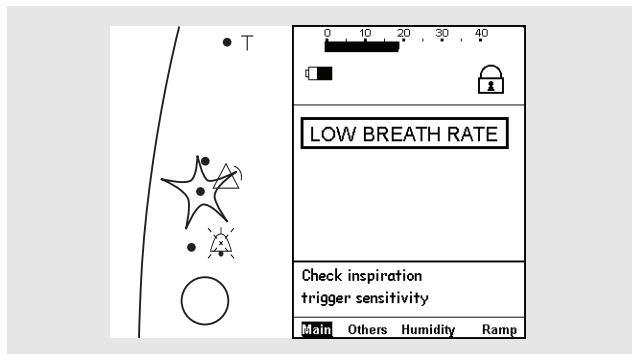

The alarm is given audibly with a tone and visibly by the yellow alarm LED and a display message.

## High Breath Rate Alarm

ITEM	DESCRIPTION
<b>Definition</b>	A high breath rate alarm will be given when the delivered breath rate exceeds the high breath rate alarm limit for 15 seconds.
<b>Possible cause</b>	The alarm for high breath rate is activated if the patient hyperventilates or if the ventilator starts to self-trigger because of incorrect settings.
<b>Ventilator action</b>	The Vivo 40 will continue to give breaths with the same settings.

### Indication

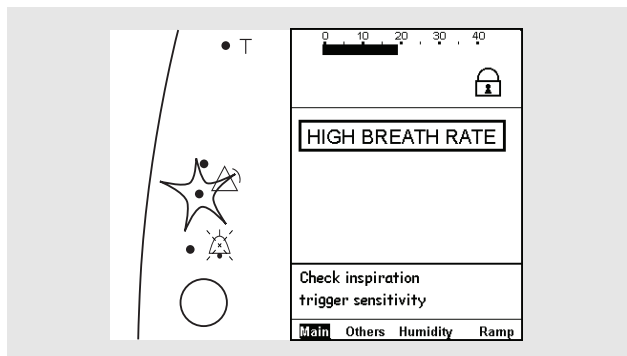

The alarm is given audibly with a tone and visibly by the yellow alarm LED and a display message.

## Low Leakage Alarm

ITEM	DESCRIPTION
<b>Definition</b>	A low leakage alarm will be given when the measured flow is lower than the expected leakage flow at set pressure.
<b>Possible cause</b>	<ul style="list-style-type: none"><li>• Incorrect patient circuit leakage.</li><li>• Obstructed or occluded patient circuit.</li></ul>
<b>Ventilator action</b>	The Vivo 40 tries to continue delivering breaths according to settings.

### Indication

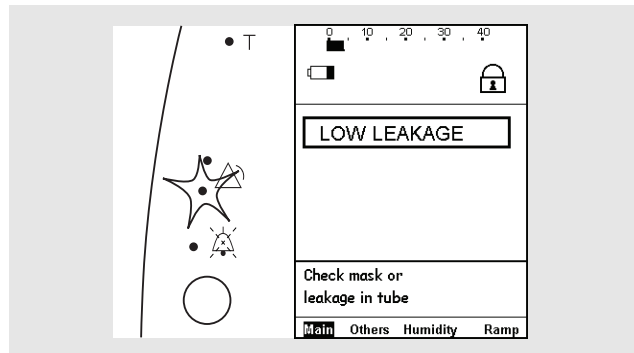

The alarm is given audibly with a tone and visibly by the yellow alarm LED and a display message.

## High Leakage Alarm

ITEM	DESCRIPTION
<b>Definition</b>	A high leakage alarm will be given when the measured flow exceeds the expected leakage flow at set pressure during more than 15 seconds.
<b>Possible cause</b>	<ul style="list-style-type: none"><li>• Leakage in patient circuit.</li><li>• The patient has removed the mask.</li></ul>
<b>Ventilator action</b>	The Vivo 40 tries to continue delivering breaths according to settings.

### Indication

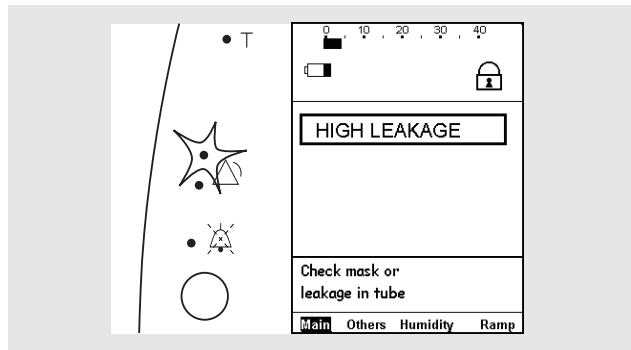

The alarm is given audibly with a tone and visibly by the red alarm LED and a display message.

## 7.3 Technical Alarm

### Low Internal Battery Warning



The low battery alarm can be triggered prematurely by a sudden increase in flow, such as an excessive leakage, a large breath or a mask off event. If this should happen, restart the Vivo 40 on internal battery. If the low battery alarm persists, the internal battery needs to be charged.

ITEM	DESCRIPTION
<b>Definition</b>	A low internal battery warning will be given when the internal battery is the last power source, and it falls below the voltage warning limit. Under normal circumstances, the low battery alarm will be activated approximately 15 minutes before shut-down.
<b>Possible cause</b>	A discharged internal battery.
<b>Ventilator action</b>	The Vivo 40 will continue to give breaths with the same settings.

#### Indication

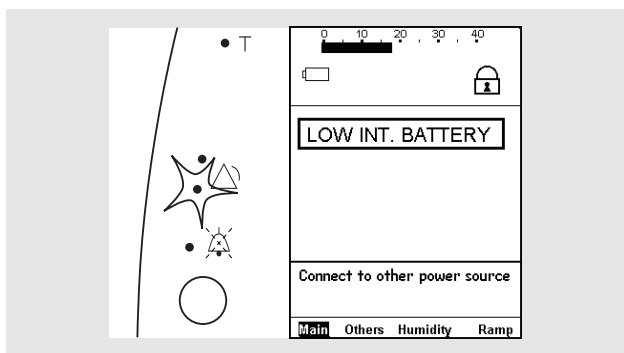

The warning is given audibly with a tone and visibly by the yellow alarm LED and a display message.

## Low Power Alarm

ITEM	DESCRIPTION
<b>Definition</b>	A low power alarm will be given when the internal battery source has fallen lower than its voltage alarm limit.
<b>Possible cause</b>	Discharged batteries.
<b>Ventilator action</b>	<b>The Vivo 40 stops giving breaths and gives alarm for 2 minutes.</b>

### Indication

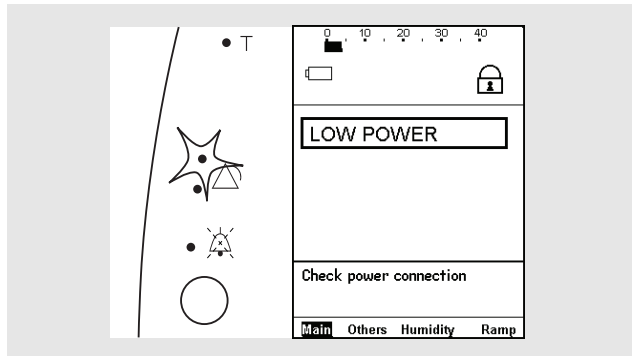

The alarm is given audibly with a tone and visibly by the red alarm LED and a display message.

## Internal Function Failure Alarms

ITEM	DESCRIPTION
<b>Definition</b>	An internal function failure alarm will be given when the Vivo 40 has an internal function failure.
<b>Ventilator action</b>	The Vivo 40 will continue or stop the treatment depending on the type and priority of the alarm.
<b>Indication</b>	The alarm is given audibly with a tone and visible by a display message at least for 120 seconds.
<b>Ventilator reset</b>	In order to stop the alarm the ventilator must be switched off by the On/Off switch on the side panel.



## 8 Cleaning the Vivo 40 and Replacement of Accessories

The patient-connected parts and the filter must be cleaned and replaced regularly to ensure correct function of the Vivo 40. All replaced parts must be disposed of in accordance with local environmental regulations regarding the disposal of used equipment and waste.

### 8.1 Cleaning the Vivo 40



To avoid electrical shock, disconnect the AC power supply to the Vivo 40 before cleaning. Do not immerse the Vivo 40 into any fluids.



- Always be careful when cleaning to ensure that you do not damage any equipment.
- Fluid must not be allowed to enter into the Vivo 40.
- Do not sterilize the Vivo 40.

#### Main Unit

1 Switch off the Vivo 40 and disconnect the power supply.

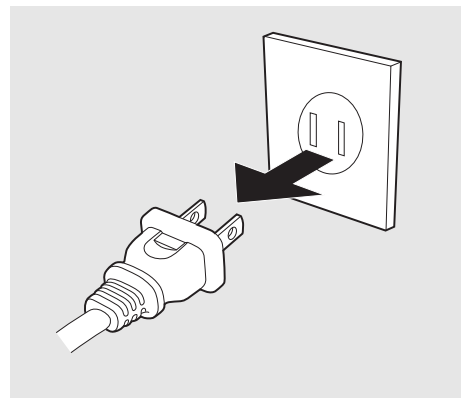

2 Remove the patient circuit.

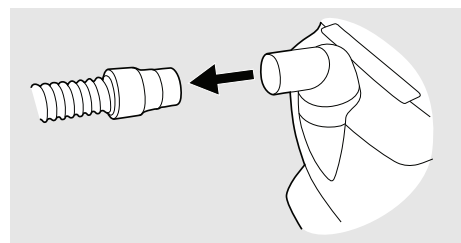

**3** At regular cleaning after normal use, keep the rear lid or HA 01 humidifier attached.

In case a more thorough cleaning is needed, detach the rear lid or the HA 01 humidifier.

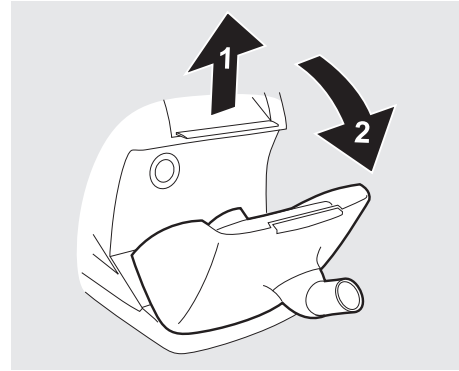

**4** Disconnect all electric cables.

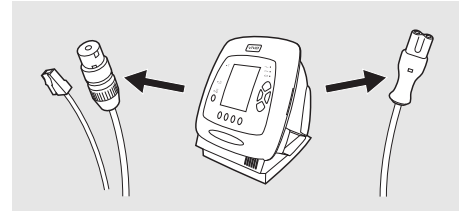

**5** Clean the outside of the Vivo 40 using a lint-free cloth and a mild soap solution. If the surface of the Vivo 40 needs to be disinfected, this can be done with Virkon® or Gigasept®.

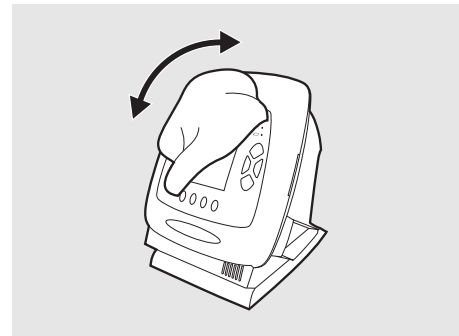

**6** Reconnect the patient circuit. Make sure all parts are dry before the Vivo 40 is put into operation.

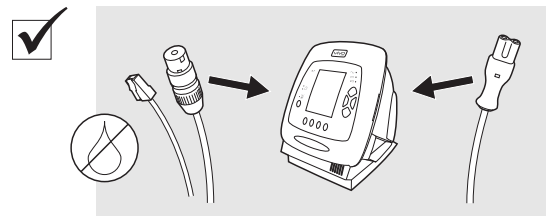

### HA 01 Humidifier

The HA 20 humidifier should be cleaned, maintained and replaced in accordance with the care provider's instructions.



*For more information, see Breas HA 01 Humidifier User Manual.*

### Patient Circuit



*The patient circuit should always be cleaned, disinfected and replaced in accordance with the care provider's instructions.*

Always replace the patient circuit with a new one when the Vivo 40 is to be used by a new patient.

All parts that come into contact with the respiration gas must be cleaned as follows:

- 1 Place the dismantled parts in hot water containing mild detergent.
- 2 Remove fouling with a brush.
- 3 Rinse parts thoroughly under running hot water.
- 4 Shake water out of all parts.
- 5 Dry the parts completely.
- 6 Store in dust-free location.

Check the patient circuit for damage regularly. In case of damage, replace the circuit.

## 8.2 Cleaning and Replacing the Patient Air Filters

The patient air filters are located in the filter cassette at the rear of the ventilator. There are two types of filters: washable filter and disposable filter.

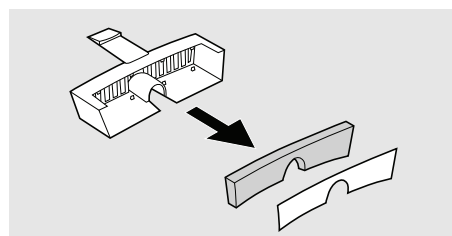
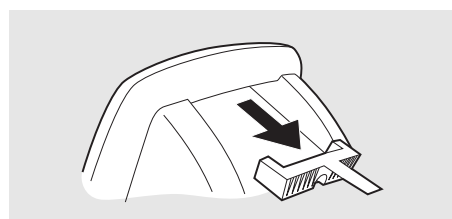

### Washable Filter (gray)

Replace the washable filter at least once a year. Wash the filter at least once a week.

- 1 Wash the filter using warm water and a mild soap.
- 2 Rinse thoroughly.
- 3 Dry the filter by squeezing it out in a towel. Do not wring the filter.

### **Disposable Filter (white)**

Replace the filter at least every 4th week, or more often when used in high pollution or pollen-rich environments.



**Do not wash or reuse the disposable filter.**

## 9 Maintenance



### **WARNING!**

- Vivo 40 should be subjected to maintenance, service and control and any applicable upgrades, in accordance with Breas service instructions.
- Vivo 40 shall only be repaired or modified in accordance with Breas service manuals, technical bulletins, and any special service instructions, by service technicians that have been authorized after Breas Vivo 40 service training, or have an equivalent technical knowledge on medical device.
- Do not under any circumstances attempt to service or repair the Vivo 40 yourself. If you do so, the manufacturer will no longer be responsible for the performance and safety of the Vivo 40.

**DEVIATION FROM THESE SERVICE INSTRUCTIONS MAY LEAD TO RISK OF PERSONAL INJURY!**

### 9.1 Regular Maintenance Control

Regular maintenance inspections and controls shall be carried out at least every 12 months. Maintenance control according to the Vivo 40 Service Manual.



**Do not use the device and contact your responsible care provider for an inspection of the device in the event of:**

- Unexpected patient symptoms during treatment.
- Unexplainable or sudden pressure, performance or sound changes during operation.
- Suspected damage to the device.

## 9.2 Service and Repair

The service and repair of the Vivo 40 must be carried out by authorized service personnel in accordance with Breas service instructions. Service inspections must always be carried out after any repair of the device.



*Authorized service workshops can order the Vivo 40 Service Manual that contains all technical documentation required for the maintenance and service of the Vivo 40.*

## 9.3 Storage

Empty, clean and dry the HA 01 humidifier (if applicable) before storage of the Vivo 40.

## 9.4 Disposal

The Vivo 40, any accessories and all replaced parts must be disposed of and recycled in accordance with the local environmental regulations regarding the disposal of used equipment and waste.



Batteries used with the Vivo 40 shall be recycled in accordance with the local environmental regulations.

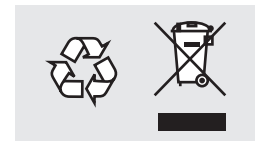

## 10 Technical Specifications

### 10.1 Data



The Vivo 40 and its packaging do not contain any natural rubber latex.

SETTING/VALUE	RANGE/PERFORMANCE	RESOLUTION
Ventilation modes	<ul style="list-style-type: none"> <li>• PSV (Pressure Support Ventilation)</li> <li>• PCV (Pressure Control Ventilation)</li> <li>• CPAP (Continuous Positive Airway Pressure)</li> </ul>	
Target Volume	<ul style="list-style-type: none"> <li>• Active</li> <li>• Inactive</li> </ul>	
Device modes	<ul style="list-style-type: none"> <li>• Clinical</li> <li>• Home</li> </ul>	
EPAP	2 cmH <sub>2</sub> O to 20 cmH <sub>2</sub> O or IPAP/IPAP <sub>min</sub> -2 cmH <sub>2</sub> O Tolerance: $\pm 2\%$ of the maximum value and $\pm 10\%$ of the set value.	0.5 below 10 cmH <sub>2</sub> O 1.0 above 10 cmH <sub>2</sub> O
IPAP	4 to 40 cmH <sub>2</sub> O Tolerance: $\pm 2\%$ of the maximum value and $\pm 10\%$ of the set value.	0.5 below 10 cmH <sub>2</sub> O 1.0 above 10 cmH <sub>2</sub> O
IPAP <sub>min</sub> (Target Volume)	4 to 40 cmH <sub>2</sub> O or to IPAP <sub>max</sub> Tolerance: $\pm 2\%$ of the maximum value and $\pm 10\%$ of the set value.	0.5 below 10 cmH <sub>2</sub> O 1.0 above 10 cmH <sub>2</sub> O
Target Volume	0.2 to 1.5 l	0.05 l

SETTING/VALUE	RANGE/PERFORMANCE	RESOLUTION
IPAPmax (Target Volume)	4 or IPAPmin to 40 cmH <sub>2</sub> O Tolerance: $\pm 2\%$ of the maximum value and $\pm 10\%$ of the set value.	0.5 below 10 cmH <sub>2</sub> O 1.0 above 10 cmH <sub>2</sub> O
CPAP	4 to 20 cmH <sub>2</sub> O. Tolerance: $\pm 2\%$ of the maximum value and $\pm 10\%$ of the set value.	0.5 below 10 cmH <sub>2</sub> O 1.0 above 10 cmH <sub>2</sub> O
Breath rate	4 to 40 breaths per minute (BPM), tolerance: $\pm 10\%$ of set value.	1 BPM
Inspiration time	0.3 to 5 sec, tolerance: $\pm 10\%$ of set value.	0.1 sec
Min inspiration time	Off, 0.3 to 3 sec	0.1 sec
Max inspiration time	0.3 to 3 sec, Off	0.1 sec
Rise time	1 to 9	1
Inspiratory trigger effort level	1 to 9, Off.	1
Expiratory trigger effort level	1 to 9, where 1 is the lowest effort and 9 is the highest effort setting.	1
Ramp function	On, Off, Disabled	
HA 01 humidifier	Settings: Off, 1 to 9, corresponds to 10 to 30 mgH <sub>2</sub> O/l, <100% RH. Heat-up time from 73°F (23°C): less than 1 hour. Max gas temperature at patient port: 109°F (43°C).	1
Audible alarm level	1 to 9, where 1 is the lowest and 9 is the highest volume setting.	1



SETTING/VALUE	RANGE/PERFORMANCE	RESOLUTION
Maximum flow	> 200 liter/min	
Maximum limited pressure during single fault condition	PCV, PSV: 60 cmH <sub>2</sub> O CPAP: 30 cmH <sub>2</sub> O	
Maximum steady limiting pressure	Set IPAP + 10 cmH <sub>2</sub> O, tolerance: ±10%	
Max flow in CPAP mode	1/3 of max press.: 110 liter/min 2/3 of max press.: 150 liter/min Max pressure: 155 liter/min	
Breathing resistance under single-fault	4 cmH <sub>2</sub> O at 30 liter/min 6 cmH <sub>2</sub> O at 60 liter/min	
Sound level at 10 cmH <sub>2</sub> O	Less than 30 dB(A)	Measured at 1 m

INDICATOR	SPECIFICATION	RESOLUTION
Pressure	0 to 40 cmH <sub>2</sub> O	±2% of full scale and ±4% of actual reading
Estimated tidal volume	liter (BTPS, Body Temperature and Pressure Saturated)	±20% or ±20 ml, whichever is the greatest.
Leakage	liter/min (BTPS)	1 liter/min, ±20%
Total rate	BPM (Breath Per Minute)	1
I:E	1:10 to 10:1	0.1 unit, ±1 unit

ALARM	SPECIFICATION	INDICATION
Auditory alarm signal pressure	45 to 85 dB(A)	±5 dB(A). Measured at 1 m.
Low pressure alarm	2 cmH <sub>2</sub> O to IPAP/IPAPmin resolution 1 cmH <sub>2</sub> O	Red LED, audible alarm and a warning message on the display.

<b>ALARM</b>	<b>SPECIFICATION</b>	<b>INDICATION</b>
High pressure alarm	Self adjusting	Red LED, audible alarm and a warning message on the display.
Low volume alarm	0.03 l to 2.0 l resolution 0.05 l	Red LED, audible alarm and a warning message on the display. Accuracy: 0.05 l.
Low breath rate alarm	4 BPM to 50 BPM resolution 1 BPM	Yellow LED, audible alarm and a warning message on the display.
High breath rate alarm	10 BPM to 60 BPM, Off resolution 1 BPM	Yellow LED, audible alarm and a warning message on the display.
Low leakage alarm	Self adjusting	Yellow LED, audible alarm and a warning message on the display.
High leakage alarm	Self adjusting	Red LED, audible alarm and a warning message on the display.
Low Internal Battery Warning	16.3 V	Yellow LED, audible alarm and a warning message on the display.
Low power alarm	AC power: 65 ±15 V AC Ext. DC 12 V: 10.0 ±0.5 V Ext. DC 24 V: 20.0 ±0.5 V Int. Batt.: 14 ±0.75 V	Red LED, audible alarm and a warning message on the display.
Internal function failure alarms		Red or yellow LED, audible alarm and a warning message on the display.
<b>POWER SUPPLIES</b>	<b>SPECIFICATION</b>	
AC power supply	100 to 240 V AC, tolerance: +10%/-20%, 50 to 60 Hz, max 140 VA	

<b>POWER SUPPLIES</b>	<b>SPECIFICATION</b>
Internal battery	Capacity 3.8 Ah. NiMH (Nickel-Metal Hydride). Operational time 3 hours, lifetime 3 years.
External battery	12/24 V DC, tolerance: +20%/-15% (10.5 to 15 V/20.4 to 30 V). Max 120 W with Breas external battery.

<b>ENVIRONMENTAL CONDITIONS</b>	<b>SPECIFICATION</b>
Operating temperature range	41 to 100°F (5 to 38°C)
Storage and transport temperature	-4 to +140°F (-20 to +60°C)
Ambient pressure range	600 to 1060 cmH <sub>2</sub> O, corresponding to ~4000 metres above sea level to ~375 metres below sea level, at normal atmospheric pressure.
Humidity	10% to 95%, non-condensing

<b>OPERATING CONDITIONS</b>	<b>SPECIFICATION</b>
Recommended leakage	20 to 40 liter/min at 10 cmH <sub>2</sub> O
Minimum leakage	12 liter/min at 4 cmH <sub>2</sub> O

<b>DIMENSIONS</b>	<b>SPECIFICATIONS</b>
W × H × D	7.48 × 9.57 × 8.78 inch (with rear lid)
Weight	8.8 lbs (with rear lid)
Air outlet	22 mm male conical standard connector

# 11 Accessories

## 11.1 Breas Accessories List



Only use accessories recommended by Breas Medical AB. Breas Medical AB cannot guarantee the performance and safety for the use of other accessories with the Vivo 40.

The following Breas accessories are currently available for the Vivo 40:

DESCRIPTION	PART NO.
Carry bag	003519
Users manual	003819
Patient tube	004465
HA 01 humidifier	003530
Rear lid	003591
Filter (grey, washable)	003563 (5 pcs)
Filter (white, disposable)	003564 (5 pcs)
Leakage/Exhalation port	004426
Trach elbow	004810
Low resistance bacteria filter (303 Respigard-II Filter)	004185
Power cord (Vivo)	003522
External DC cable	003584



Accessory equipment connected to the analog and digital interfaces must be certified according to the respective IEC standards (e.g. IEC 60950 for data processing equipment and IEC 60601-1 for medical equipment). Furthermore all configurations shall comply with the valid version of the system standard IEC 60601-1-1. Everybody who connects additional equipment to the signal input part or signal output part configures a medical system, and is therefore responsible that the system complies with the requirements of the valid version of the system standard IEC 60601-1-1. If in doubt, consult the technical service department or your local representative.

# 12 Patient Settings

## Patient Settings - Breas Vivo 40

Patient .....

Date .....

Clinic .....

Set by .....

<input type="checkbox"/>	<input type="checkbox"/>	<input type="checkbox"/>
PCV	PSV	CPAP

IPAP ..... Max Inspiration Time .....

IPAPmin ..... Min Inspiration Time .....

EPAP ..... Inspiration Time .....

Breath Rate ..... Inspiration Trigger .....

Rise Time ..... Expiration Trigger .....

Target Volume..... CPAP .....

IPAPmax  .....

Ramp .....

Humidifier .....

Notes .....

.....

.....

.....

.....

